

Starlight Xpress Ltd

SXV-M5 CCD camera user manual



Thank you for purchasing a Starlight Xpress CCD camera. We hope that you will be very satisfied with the results. The SXV-M5 is a medium-resolution cooled CCD camera, especially designed for astronomical imaging. The SXV-M5 uses a Sony SuperHAD CCD, with 500 x 582 pixels in a 4.9mm x 3.65mm active area. SuperHAD devices have the greatest quantum efficiency of any interline transfer CCD currently available and the use of high performance microlenses on the CCD surface gives the greatest possible throughput of light to the pixels. This camera is a next generation version of the parallel port driven MX516, but the use of an internal USB2 interface and the addition of an external guide camera option makes it considerably more effective.

Please take a few minutes to study the contents of this manual, which will help you to get the camera into operation quickly and without problems. I am sure that you want to see some results as soon as possible, so please move on to the 'Quick Start' section, which follows. A more detailed description of imaging techniques will be found in a later part of this manual.

‘Quick Starting’ your SXV-M5 system

In the shipping container you will find the following items:

- 1) The SXV-M5 camera head.
- 2) A power supply module.
- 3) A 3 metre USB camera cable.
- 4) An adaptor for 1.25” drawtubes.
- 5) A CD with the ‘SXV_M5’ software.
- 6) This manual.

You will also need a PC computer with Windows 98SE, Windows 2000 or Windows XP. This machine must have at least one USB port (ideally USB2.0) and at least 64 Megs of memory. If you intend to view the finished images on its screen, then you will also need a graphics card capable of displaying an image with a minimum of 800 x 600 pixels and 65,000 colours. A medium specification Pentium with between 500MHz and 3GHz processor speed is ideal.

Connecting up:

Plug the 5 pin DIN connector into the socket on the power supply box, and plug the power supply into the wall socket. The yellow LED on the power supply should light.

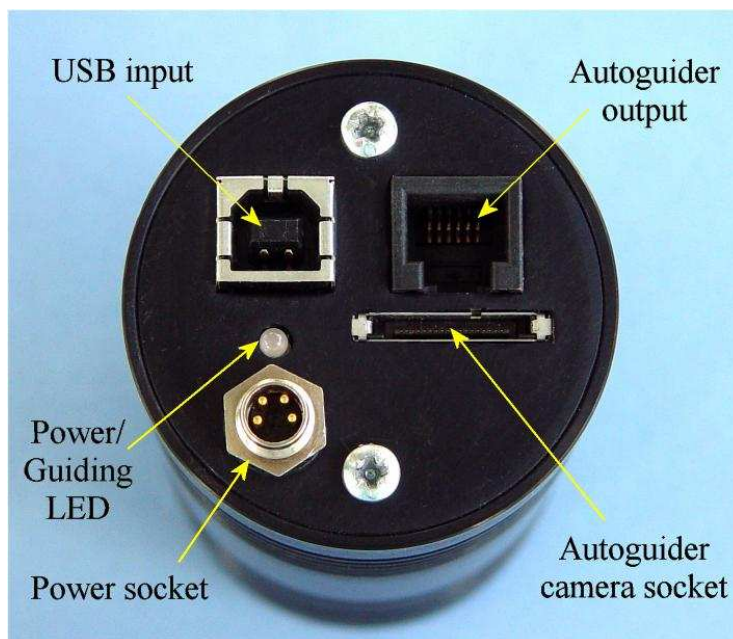

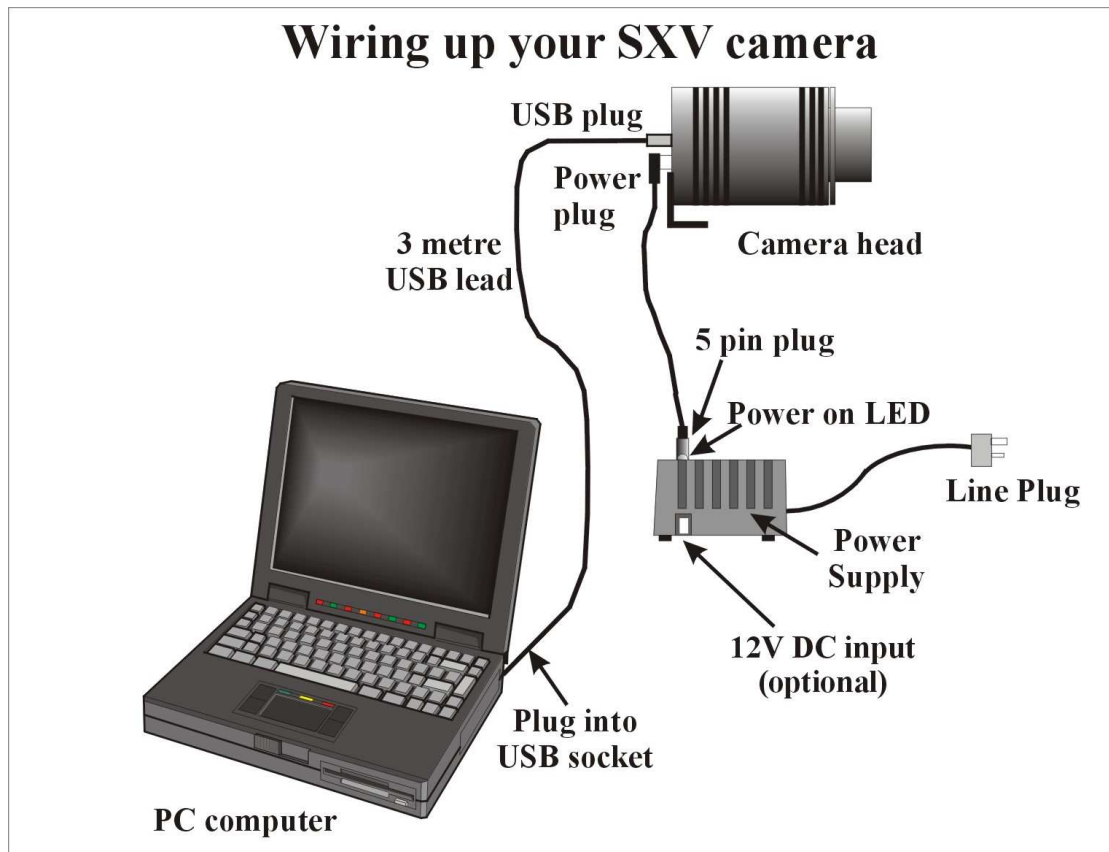

Connect the miniature 4 way power plug to the socket on the rear of the camera and screw the retaining ring into place. The LED on the rear of the camera will light a dim yellow. The other connections should not be attached until after the software has been installed.

Installing the software:

Switch on the computer and allow it to 'boot up'. Once you have the system ready to run, insert the program disk into your CD drive and select 'Setup.exe' if the disk does not autostart. The initial installation is to set up the USB drivers required by the SXV electronics. The files SXVIO.sys and Generic.sys are copied to your Windows\System32\Drivers folder and SXV_M5.inf is copied to Windows\Inf. After this, the program 'SXV_M5.exe' will be installed into your 'CCD' directory and a new directory called 'Autosave' will now exist on the same drive. 'Autosave' is where SXV_M5 will normally store its configuration file, 'SXVM5.ini', and any image files, which are recorded using the 'Autosave' mode in SXV_M5 and saved in FITs format.

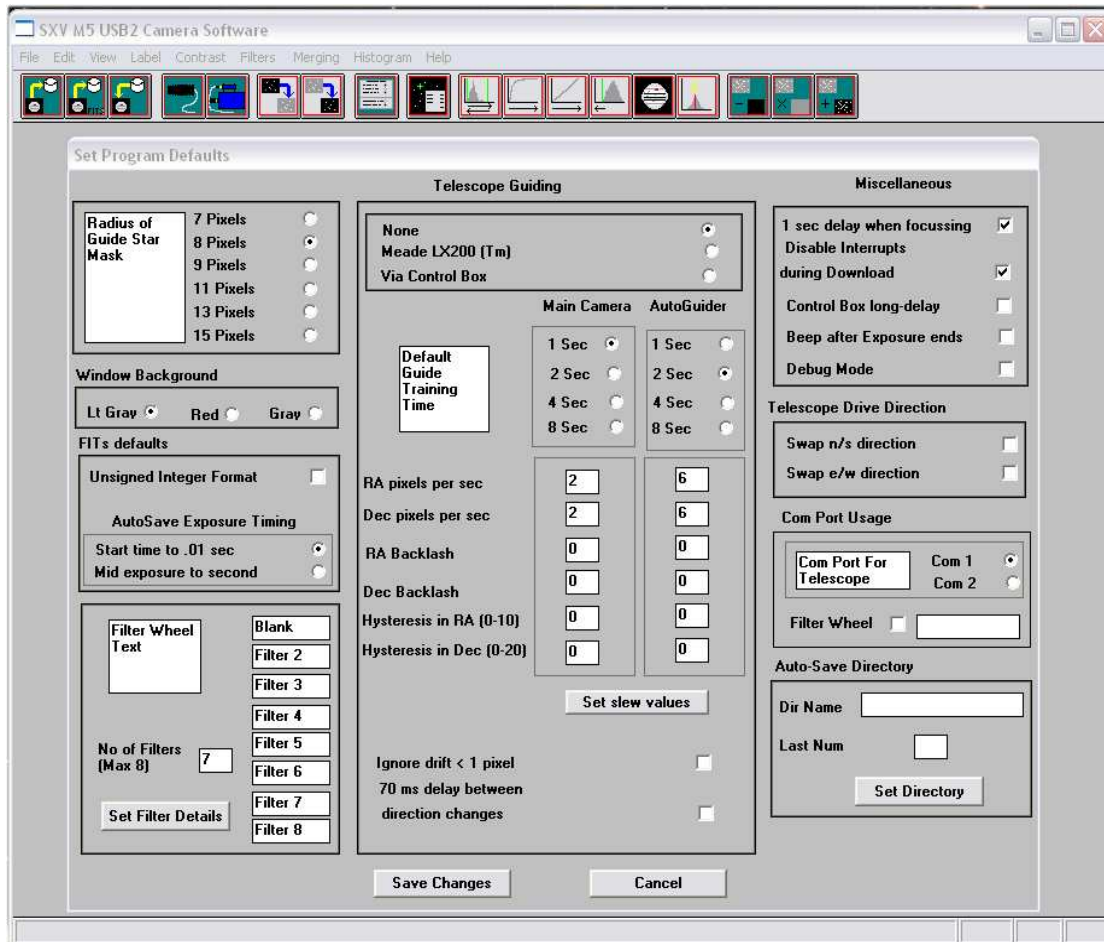

You now need to set up the camera control defaults (shown above), as follows: Start SXV-M5 by clicking on the icon and select the 'File' menu. Now select 'Set program defaults' and a window, which contains the various software settings, will appear. Suggested starting defaults are as follows:

- 1) Background Image area Red (or as preferred)
- 2) Interlaced image smoothing On
- 3) FITS Unsigned Integer format Off
- 4) Star mask size (area used for photometry and guiding) 8 pixels

The other default settings are not important for current purposes and may be left as the software start-up values for now.

Recording your first image:

We now have the camera and computer set up to take pictures, but an optical system is needed to project an image onto the CCD surface. You could use your telescope, but this introduces additional complications, which are best avoided at this early stage. There are two simple options, one of which is available to everyone:

- 1) Attach a standard 'M42' SLR camera lens to the SXV-M5, using a 27mm spacer to achieve the correct focal distance. M42 thread spacers are available from most photographic stores, or from Starlight Xpress dealers.

- 2) Create a 'Pin hole' lens by sticking a sheet of aluminium baking foil over the end of the 1.25" adaptor and pricking its centre with a small pin.

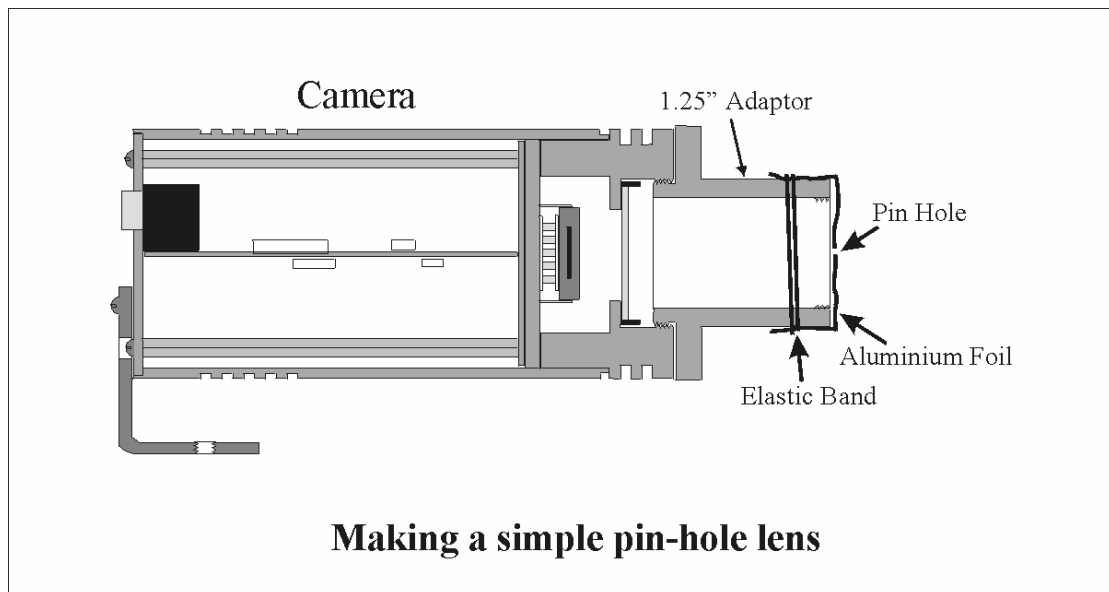
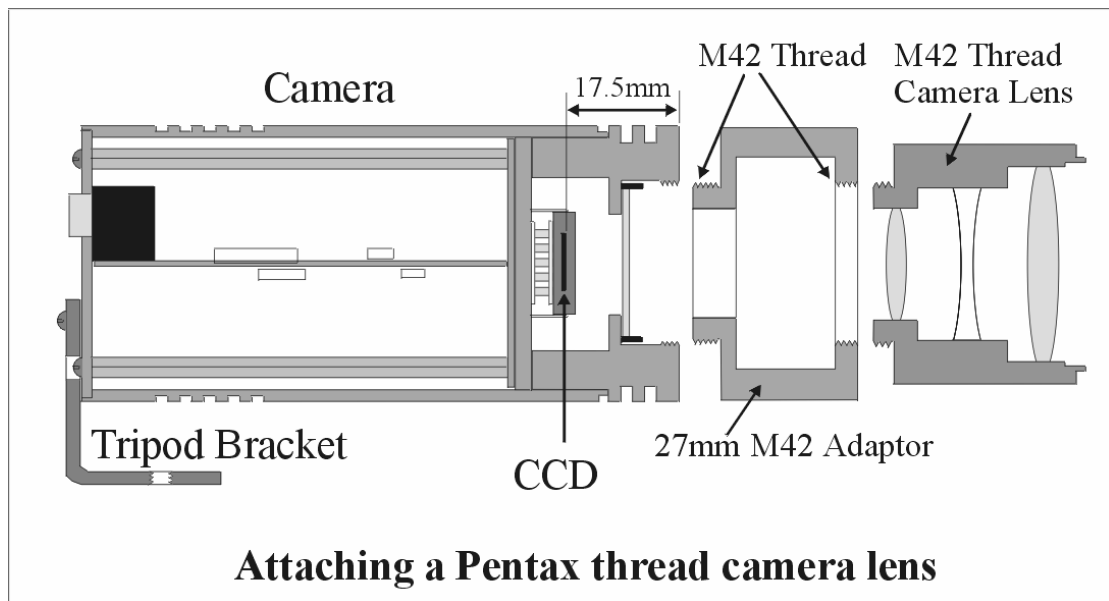

If you use a normal lens, then stop it down to the smallest aperture number possible (usually F22) as this will minimise focus problems and keep the light level reasonable for daytime testing. The pin hole needs no such adjustments and will work immediately, although somewhat fuzzily.

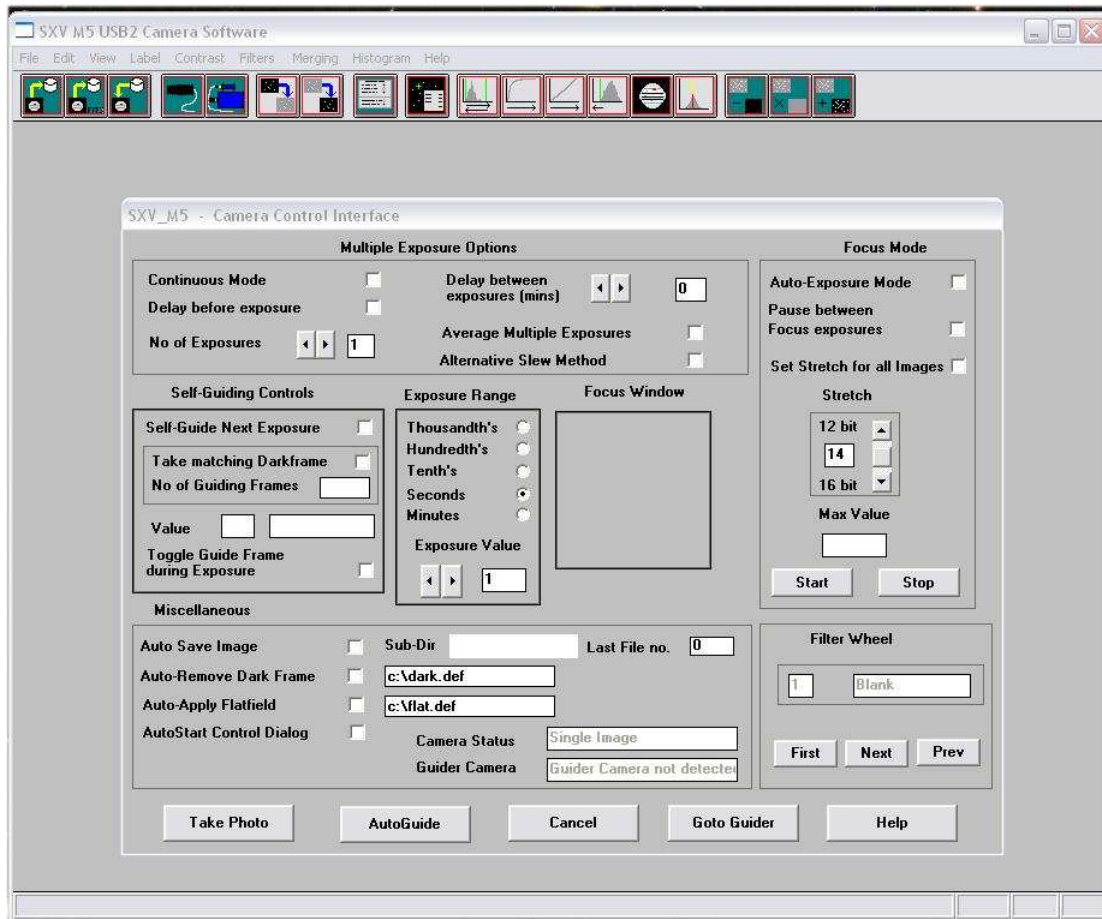

Point the camera + lens or pinhole towards a well-lit and clearly defined object some distance away. Now click on the camera icon in the toolbar of the SXV-M5 software and the camera control panel will appear (see above). Select an exposure time of 0.1 seconds and press 'Take photo'. After the exposure and download have completed (between 1 and 3 seconds) an image of some kind will appear on the computer monitor. It will probably be poorly focused and incorrectly exposed, but any sort of image is better than none! In the case of the pinhole, all that you can experiment with is the exposure time, but a camera lens can be adjusted for good focus and so you might want to try this to judge the image quality that it is possible to achieve.

One potential problem with taking daylight images is the strong infrared response of the SXV-M5 and this will cause 'soft focus' with camera lenses. Soft focus with camera lenses is much reduced by keeping the aperture setting below F8. IR blocking filters are available from various suppliers (True Technology, Edmunds etc.) and are recommended for the best results.

If you cannot record any kind of image, please check the following points:

- 1) *Is the power LED on?*
- 2) *Does the software indicate that the camera is successfully connected? An attempt to take a picture will fail with an error message if the USB is not properly installed. In this case, try unplugging the USB cable and then reconnecting it after about 5*

seconds. Restart the camera software and see if it can link now. If not, check in Windows device manager (via 'System' in 'Control Panel') and see if the BlockIO device is installed properly.

3) If you cannot find any way of making the camera work, please try using it with another computer. This will confirm that the camera is OK, or otherwise, and you can then decide how to proceed. Also check on our web site to see if there are any updates or information about your camera software that might help. The message board might prove useful to ask for help with getting your camera operating properly.

Our guarantee ensures that any electrical faults are corrected quickly and at no cost to the customer.

Enhancing your image:

Your first image may now be reasonably good, but it is unlikely to be as clear and sharp as it could be. Improved focusing and exposure selection may correct these shortcomings, and you may like to try them before applying any image enhancement with the software. However, there will come a point when you say, "That's the best that I can get" and you will want to experiment with various filters and contrast operations. In the case of daylight images, the processing options are many, but there are few that will improve the picture in a useful way.

The most useful of these are the 'Normal Contrast Stretch' and the 'High Pass Low Power' filter. The high pass filter gives a moderate improvement in the image sharpness, and the effects of image processing. This can be very effective on daylight images. Too much high pass filtering results in dark borders around well-defined features and will increase the 'noise' in an image to unacceptable levels, but the 'Low Power' filter is close to optimum and gives a nicely sharpened picture, as above.

The 'Contrast' routines are used to brighten (or dull) the image highlights and shadows. A 'Normal' stretch is a simple linear operation, where two pointers (the 'black' and 'white' limits) can be set at either side of the image histogram and used to define new start and end points. The image data is then mathematically modified so that any pixels that are to the left of the 'black' pointer are set to black and any pixels to the right of the 'white' pointer are set to white. The pixels with values between the pointers are modified to fit the new brightness distribution. Try experimenting with the pointer positions until the image has a pleasing brightness and 'crispness'.

At this point, you will have a working knowledge of how to take and process an SXV-M5 image. It is time to move on to astronomical imaging, which has its own, unique, set of problems!

Astronomical Imaging with the SXV-M5

1) Getting the image onto the CCD:

It is fairly easy to find the correct focus setting for the camera when using a standard SLR lens, but quite a different matter when the M7 is attached to a telescope! The

problem is that most telescopes have a large range of focus adjustment and the CCD needs to be quite close to the correct position before you can discern details well enough to optimise the focus setting. An additional complication is the need to add various accessories between the camera and telescope in order that the image scale is suitable for the subject being imaged and (sometimes) to include a 'flip mirror' finder unit for visual object location.

A simple, but invaluable device, is the 'par-focal eyepiece'. This is an eyepiece in which the field stop is located at the same distance from the barrel end, as the CCD is from the camera barrel end.

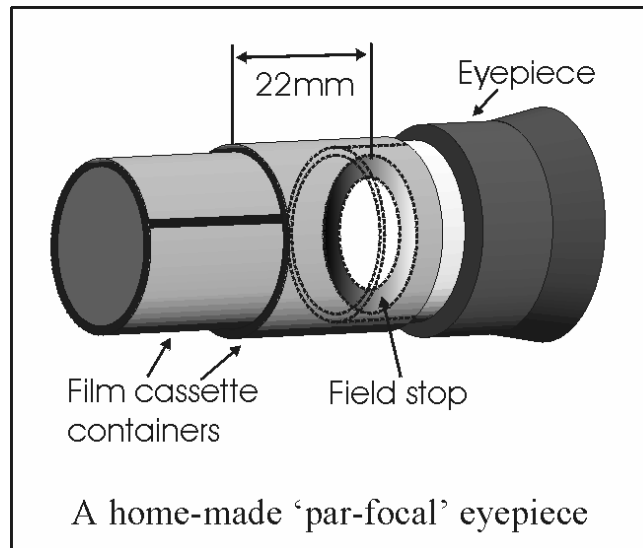

When the par-focal eyepiece is fitted into the telescope drawtube, you can adjust the focus until the view is sharply defined and the object of interest is close to the field centre. On removing the eyepiece and fitting the CCD camera, the CCD will be very close to the focal plane of the telescope and should record the stars etc. well enough for the focus to be trimmed to its optimum setting

Several astronomical stores sell par-focal eyepieces, but you can also make your own with a minimum of materials and an unwanted Kellner or Plossl ocular. Just measure a distance of 22mm from the field stop of the eyepiece (equivalent to the CCD to adaptor flange distance of the camera) and make an extension tube to set the field stop at this distance from the drawtube end. Cut-down 35mm film cassette containers are a convenient diameter for making the spacer tube and may be split to adjust their diameter to fit the drawtube.

Another popular solution to the 'find and focus' problem is the 'flip mirror' unit. These operate on a similar principle to the single lens reflex camera, where a hinged mirror can drop into the light path and reflect the image through 90 degrees into a viewing eyepiece.

In this case, the camera and eyepiece are made par-focal with each other by locking up the mirror, focusing the camera on an easy object, such as a moderately bright star and then flipping the mirror down to view the same star with the eyepiece. Once the eyepiece has been locked into the correct position, you can use it to focus on the image by lowering the flip mirror and operating the telescope focus wheel until the

image is sharp. When the mirror is raised, the image will fall onto the CCD surface and should be accurately in focus. Most flip mirror units allow several adjustments to be made, so that the image can be centred properly in the eyepiece and CCD fields, which are not necessarily coincident when you first buy your unit!

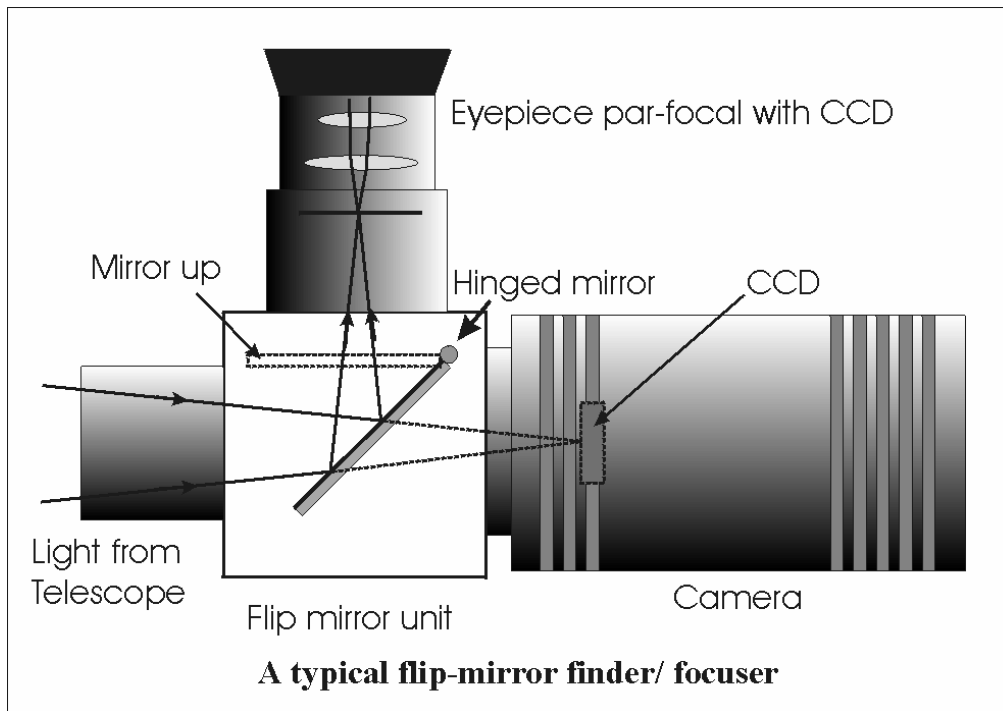

Opinions vary as to the utility of flip mirrors. They are a convenient way to find and focus, but they add quite a bit of extra length between the camera and telescope. This can be very inconvenient with Newtonians, and not a lot better with SCTs, especially if the assembly is somewhat flexible. They also make it difficult to use a focal reducer with your camera, as the rapidly converging light cone from a reducer cannot reach all the way through the flip mirror unit to the CCD surface. If you are using one of the popular F3.3 compressors for deep sky imaging, you will NOT be able to include a flip mirror unit in front of your camera and a par-focal eyepiece is your best option.

Whichever device you use, it is necessary to set up a good optical match between your MX7 and the telescope. Most SCTs have a focal ratio of around F10, which is too high for most deep sky objects and too low for the planets! This problem is quite easy to overcome, if you have access to a telecompressor (for deep sky) and a Barlow lens for planetary work. The new Meade F3.3 compressor is very useful for CCD imaging and I can recommend it from personal experience. It does not require a yellow filter for aberration correction, unlike some other designs, so it can be used for colour imaging. Barlow lenses are less critical and most types can be used with good results. However, if you are buying one for CCD imaging, I recommend a 3x or 5x amplifier, or the planets will still be rather small in your images. As a guide, most CCD astronomers try to maintain an image scale of about 2 arc seconds per pixel for deep sky images. This matches the telescope resolution to the CCD resolution and avoids 'undersampling' the image, which can result in square stars and other unwanted effects. To calculate the focal length required for this condition to exist, you can use the following simple equation:

$$F = \text{Pixel size} * 205920 / \text{Resolution (in arc seconds)}$$

In the case of the SXV-M5 and a 2 arc seconds per pixel resolution, we get

$$F = 0.0082 * 205920 / 2 = 844\text{mm}$$

For a 200mm SCT, this is an F ratio of $844 / 200 = F4.22$, which is easily achieved with the Meade converter and appropriate extension tube (as supplied with the converter). Moderate deviations from this focal length will not have a drastic effect and so any F ratio from about F3.3 to F6 will give good results.

The same equation can be used to calculate the amplification required for good planetary images. However, in this case, the shorter exposures allow us to assume a much better telescope resolution and 0.25 arc seconds per pixel is a good value to use. The calculation now gives the following result:

$$F = 0.0082 * 205920 / 0.25 = 6754\text{mm}$$

This is approximately F34 when used with a 200mm SCT and so we will need a 3.4 x Barlow lens. Such lenses are not available, but the common 3x version will be good enough for all practical purposes.

An accessory that you will find valuable is the 'M42 to T' adaptor. These are short tubes that carry an external M42 thread at one end and an internal 'T' thread at the other end, and are available from most photographic supply shops. The T thread is the same diameter as the M42 (42mm x 1mm) thread but has a pitch of 0.75mm and is used for many astronomical accessories, such as telecompressors. An M42 to T adaptor will allow you to easily interface with virtually any device in the astronomical catalogue.

Achieving a good focus:

Your starting point will depend on the focus aids, if any, which you are using. With the par-focal eyepiece, you should slip the eyepiece into the drawtube and focus visually on a moderately bright star (about 3rd magnitude). Now withdraw the eyepiece and carefully insert the camera nosepiece until it is bottomed against the drawtube end and lock it in place. With the flip mirror unit, all that is needed is to swing the mirror down and adjust the focus until the star is sharply defined and centred in the viewing eyepiece. Now lift the mirror and you are ready to start imaging.

SXV_M5 has a focus routine that will repeatedly download and display a 100 x 100 pixel segment of the image at relatively high speed. This focus window may be positioned anywhere in the camera field and can be displayed with an adjustable degree of automatic contrast stretching (for focusing on faint stars). To use this mode, start up the software and select the MX camera interface (File menu). Set the camera mode to 'Fast' and select an exposure time of 1 second. Press 'Take Picture' and wait for the image to download. There is a good chance that your selected star will appear somewhere within the image frame and it should be close to a sharp focus. If the focus is still poor, then it may appear as a pale disk of light with a dark centre (the secondary mirror shadow in an SCT, or Newtonian). Now select the 'File' menu again

and click on 'Focus frame centre'; you can now use the mouse pointer to click on the star image and the new focus frame co-ordinates will be displayed. Now return to the camera interface window and click on 'Start' in the Focus frame. The computer will now display a continuous series of 100 x 100 pixel images in the focus window and you should see your selected star appear somewhere close to the centre. A 'peak value' (the value of the brightest pixel) will also be shown in the adjacent text box and this can be used as an indication of the focus accuracy. Although the peak value is sensitive to vibration and seeing, it tends towards a maximum as the focus is optimised. Carefully adjust the focus control on your telescope until the image is as sharp as possible and the peak value reaches a maximum. Wait for any vibration to die down before accepting the reading as reliable and watch out for bursts of bad seeing, which reduce the apparent focus quality. Quite often, the peak value will increase to the point where it is 'off scale' at 4095 and in this case you must halt the focus sequence and select a shorter exposure if you wish to use the peak value as an indicator. Once you are happy with the focus quality achieved, you might like to trim the settings of your par-focal or flip mirror eyepiece to match the current camera position. Although you can reach a good focus by the above method, many observers prefer to use additional aids, such as Hartmann masks (an objective cover with two or three spaced holes) or diffraction bars (narrow parallel rods across the telescope aperture). These make the point of precise focus easier to determine by creating 'double images' or bright diffraction spikes around stars, which merge at the setting of exact focus. The 12-16 bit slider control allows you to adjust the contrast of the focus frame for best visibility of the star image. It defaults to maximum stretch (12 bits), which is generally ideal for stars, but a lower stretch value is better for focusing on planets.

Taking your first astronomical image:

I will assume that you are now set up with a focused camera attached to a telescope with an operating sidereal drive. If so, you are now in a position to take a moderately long exposure of some interesting deep-sky astronomical object (I will deal with planets later!). As most drives are not very accurate beyond a minute or two of exposure time, I suggest that you find a fairly bright object to image, such as M42, M13, M27 or M57. There are many others to choose from, but these are good examples.

Use the finder to align on your chosen object and then centre accurately by using the focus frame and a short exposure of between 1 and 5 seconds. The '12-16 bit' slider in the focus frame allows you to adjust the image contrast if you find that the object is too faint with a short exposure. Once properly centred and focused, take an exposure of about 60 seconds, using the 'Fast' mode and observe the result. Initially, the image may appear rather barren and show only a few stars, however, there is a great deal of data hidden from view. You can get to see a lot of this, without affecting the image data, if you go to the 'View' menu and select 'Auto Contrast Stretch Image'. The faint image data will then appear in considerable detail and I think that you will be impressed by the result!

If you are happy with the image, go to the 'File' menu and save it in a convenient directory.

Now you need a 'dark frame', if the best results are to be extracted from your raw image. To take this, just cover the telescope objective with the lens cap, or drop the flip mirror to block the light path to the CCD (make sure that this is light tight), and take another 60 second exposure. This image will be a picture of the dark signal generated during your exposure and it should be saved with your image for use in processing the picture. The SXV-M5 generates very little dark signal and so dark frames are not essential for short exposures of less than a few minutes, but it is a good idea to record at least one for each exposure time used during an imaging session. As variations in ambient temperature will affect the dark signal, it is best to take the dark frames within a few minutes of capturing your images. For the same reason, it is not wise to use 'old' dark frames if you want the best possible results, however, some software allows you to scale library dark frames to match the image (e.g. AstroArt).

'Flat fields' are often recommended for optimising the results from your CCD camera, but these are generally less important than dark frames, especially if you make sure that the optical window of the camera is kept dust-free. The purpose of a flat field is to compensate for uneven illumination and sensitivity of the CCD and it is better to avoid the need for one by keeping the optics clean and unvignetted. I will ignore flat fielding for current purposes and describe the process in detail at a later stage.

Processing the deep-sky image:



1) Make sure the 'Auto Contrast Stretch' is switched off and load your image into SXV_M5. Select 'Merge' and then 'Subtract Dark Frame'. Pick the appropriate dark

frame and the software will then remove the dark signal from your image, leaving it somewhat darker and smoother than before.



- 2) The resulting image will probably look faint and dull, with a bright background due to light pollution. It is now time to process the 'luminance' (brightness and contrast) of the image to get the best visual appearance. First, use the 'Normal' contrast stretch to darken the background by setting the 'Black' slider just below the main peak of the histogram. Alternatively, you can use the 'Remove Background' option to let the software decide on the best setting. This will greatly reduce the background brightness and the image will begin to look rather more attractive. You can now try brightening the highlights with another 'Normal' stretch, in which you bring down the 'White' slider to just above the main image peak. The best setting for this is rather more difficult to guess and you may need several attempts before the result is ideal. Just use the 'Undo last filter' function, if necessary, to correct a mistake.



3) The image will now look quite impressive and I hope that you are pleased with your first efforts! Further small refinements are usually possible and you will become expert at judging the best way to achieve these as your experience increases. As a rough guide, the 'Filters' menu can be used to sharpen, soften or noise reduce the image. Strong 'High Pass' filters are usually not a good idea with deep sky images, as the noise will be strongly increased and dark rings will appear around the stars, but a 'Median' filter can remove odd speckles and a mild 'Unsharp Mask' (Radius 3, Power 1) will sharpen without too much increase in noise.

Other things to try, include adjustment of the colour saturation and summing several images for a better signal to noise ratio. Summing can be done in the 'Merge' menu and involves loading the first (finished) image, selecting a reference point (a star) then loading the second image and finding the same star with the mouse. Once the reference is selected, you can either add directly, or average the images together. Averaging is generally better, as you are less likely to saturate the highlights of the picture. The signal-to-noise ratio will improve at a rate proportional to the square root of the number of summations (summing 4 images will double the signal-to-noise), but **different** exposures must be used. Summing an image with itself will not change the S/N ratio!

Although I have concentrated on the use of a telescope for deep-sky imaging, do not forget that you have the option of using an ordinary camera lens for impressive wide-field shots! A good quality 200mm F3.5 lens with an infrared blocking filter will yield very nice images of large objects, such as M31, M42, M45 etc. If you cannot obtain a large IR blocker for the front of the lens, it is quite acceptable to place a small one behind the lens, inside the adaptor tube.

Taking pictures of the planets:

Planetary imaging is in many ways quite different from deep sky imaging. Most deep sky objects are faint and relatively large, so a short focal length and a long exposure are needed, while planets are bright and very small, needing long focal lengths and short exposures. High resolution is critical to achieving good results and I have already shown how a suitable focal length can be calculated and produced, using a Barlow Lens.

Many camera users comment on the difficulty of finding the correct focus when taking pictures of Jupiter etc. This is usually due to poor seeing conditions, which are only too common, but may be due in part to poor collimation of your telescope. Please ensure that the optics are properly aligned as shown by star testing, or by using one of the patent collimation aids that are widely available. It is also better to use a star for initial focusing, as planetary detail is difficult to judge in bad seeing. Although the star will also suffer from blurring, the eye can more easily gauge when the most compact blur has been achieved!

You could begin by imaging lunar craters, but the colour content is low and so I recommend Jupiter, Saturn or Mars. The rapid variations of seeing which accompany

planetary imaging, will ruin the definition of about 95% of your images and so I recommend setting the camera to run in 'Autosave' mode. This will automatically take a sequence of images and save them with sequential file names in your 'Autosave' directory. Dozens of images will be saved, but only one or two will be satisfactory for further processing.

To start the Autosave process, call up the SXV Camera Interface and select the 'Continuous Mode' check box at the top (make sure the rest are unchecked). Now check the 'Autosave Image' checkbox near the bottom of the window. If you now click on 'Take Picture' the automatic sequence will begin and will not stop until you press a computer key. The images will be saved in FITs format with sequential names such as 'Img23, Img24....' and will be found in the 'Autosave' directory (or a sub-directory of Autosave, set up in the program defaults menu).

The exposure time needed for good planetary images is such that the image histogram has a peak value at around 127 and does not extend much above 200 (Ignore the major peak near zero, due to the dark background). If you use too short an exposure time, the image noise level will be increased, and if too long a time is used you will saturate the highlights and cause white patches on the decoded image. With the recommended focal length, Jupiter and Mars will both need an exposure time of between 0.1 and 1 seconds and Saturn will need between 0.5 and 2 seconds.

Processing a planetary image:

Planetary images have one major advantage over deep sky images, when you come to process them – they are MUCH brighter, with a correspondingly better signal to noise ratio. This means that aggressive sharpening filters may be used without making the result look very noisy and so some of the effects of poor seeing can be neutralised.

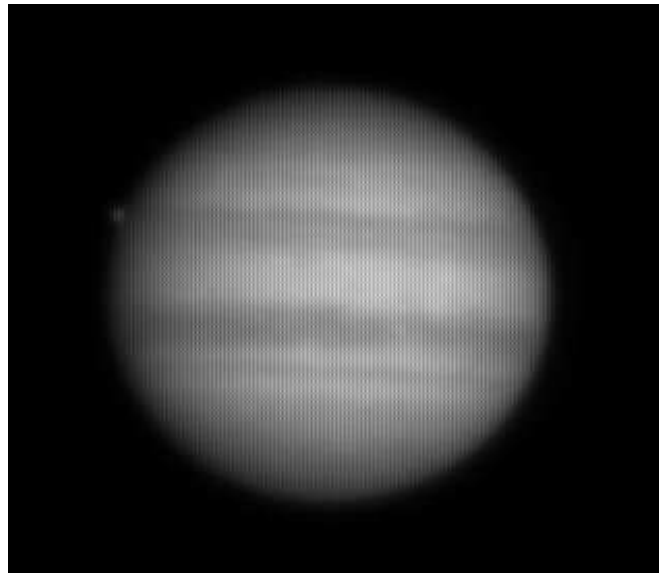

A raw image

Try applying an 'Unsharp Mask' filter with a radius of 5 and a power of 5. This will greatly increase the visibility of any detail on the planet, but the optimum radius and power will have to be determined by experiment. In general terms, the larger the image and the worse the seeing, then the wider the radius for best results. My Jupiter

shots are usually about half the height of the CCD frame and I find that the ‘radius 5, power 5’ values are good for most average seeing conditions. If you have exceptionally good conditions, then a reduction to R=3, P=3 will probably give a more natural look to the image, as too large a radius and power tends to outline edges with dark or bright borders.

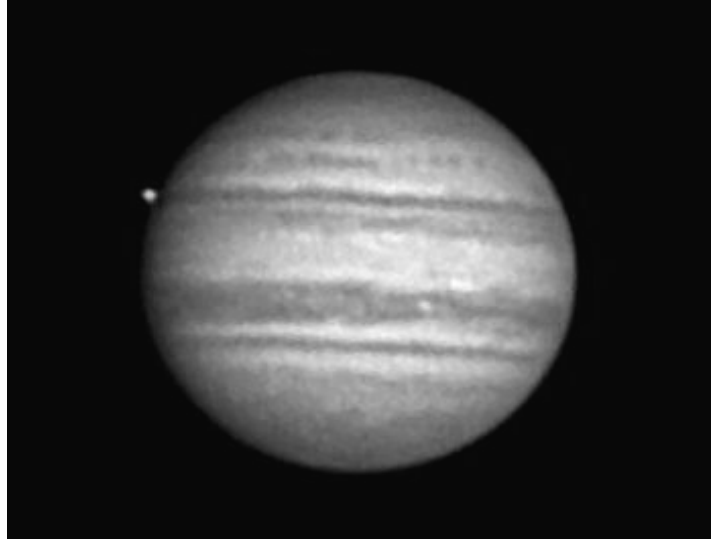

As a finishing touch, the application of a Median filter or a Weighted Mean Low Pass filter can be useful to smooth out the high frequency noise after a strong Unsharp Mask.

As with deep-sky images, it is advantageous to sum planetary images together to improve the signal to noise ratio. In this case, the ‘averaging’ option should always be used, or the result is likely to exceed the dynamic range of the software and saturate the highlights. Aligning the images is always something of a problem, as there are rarely any stars to use when imaging the planets, but Jupiter’s satellites can be useful reference points. Otherwise, you will have to find a well-defined feature on the planet, or estimate where the centre of the disk is located. Some more sophisticated software can automatically align planetary images, but I do not find it especially difficult to do by eye.

Other features of SXV_M5

‘Slew & Sum’ imaging:

The SXV-M5 can be used in an automatic image-stacking mode, called ‘Slew & Sum’. The camera is set to take several sequential exposures, which are automatically ‘slewed’ into alignment and then summed together by the software. This mode can help to overcome a poor RA drive by summing images that have exposure times shorter than the drive error period. The resulting image has more noise than a single exposure of the same total length, but this method of imaging is still an effective way of making long exposures.

To take an S&S image, go to the camera interface window and select an exposure time for one image of the sequence. Do not use a very short exposure time, as the read-out noise will become dominant. About 30 seconds is a reasonable minimum. Now go to the 'Multiple Exposure Options' and select a number of exposures to take. You can also select to average the images, rather than adding them, and there is a 'Alternative Slew Mode' available, which uses the correlation of image areas, rather than a single star. This mode can be better in dense star fields. Another option is 'Auto remove dark frame'. This is advisable with S&S images, as the slewing will mis-register the images with a single dark frame that is applied to the finished sequence. To use this option, you will need a dark frame, taken with the same exposure time as a single image from the sequence. This is stored on drive C with the name 'dark.def'

Now click on 'Take Photo' and the sequence will begin.

Taking and using a flat field:

Flat fields are images, which display only the variations of illumination and sensitivity of the CCD and are used to mathematically modify a wanted image in such a way that the errors are removed. Common flat field errors are due to dust motes on the camera window and vignetting effects in the optical system of the telescope. Dust motes act as 'inverse pinholes' and cast out-of-focus images of the telescope aperture onto the CCD chip, where they appear as shadow 'do-nuts'. Most optical systems show some vignetting at the edges of the field, especially when focal reducers are used. This causes a brighter centre to show in images, especially when there is a lot of sky light to illuminate the field.

If dust motes are your main problem, it is best to clean the camera window, rather than to rely on a flat field to remove the do-nuts. Flat fields always increase the noise in an image and so physical dust removal is the best option. If you have serious vignetting, first check whether the optical system can be improved. The most likely cause of this problem is trying to use too powerful a degree of optical compression with a focal reducer and you might want to try moving the camera closer to the reducer lens.

If you really do need to use a flat field for image correction, then it must be taken with care. It is most important that the optical system **MUST NOT** be disturbed between taking your original images and taking the flat field. Any relative changes of focus and rotation etc. will upset the match between flat field and image and the result will be poor correction of the errors. The other necessity for recording a good flat field is a source of very even illumination for the telescope field. This is surprisingly difficult to achieve and many designs of light source have appeared in the literature and on the Web. These usually consist of a large wooden box, containing several lamps and an internal coating of matt white paint, which is placed over the objective of the telescope to provide an evenly illuminated surface. These can work well, but I prefer a simpler method, as follows:

Most imaging sessions begin or end in twilight and so the dusk or dawn sky can provide a distributed source of light for a flat field. However, using the sky directly is likely to result in recording many unwanted stars, or patches of cloud etc., so a

diffuser needs to be added to the telescope. An ideal material is Mylar plastic draughting film, obtained from an office supplies warehouse. It is strong and water resistant and can be easily replaced if damaged. Stretch a piece of the film loosely across the aperture of your telescope and point the instrument high in the sky, to avoid any gradient in the light near the horizon. Now take several images with exposure times adjusted to give a bright, but not overloaded, picture. Averaging flat field together is a good way to reduce their noise contribution and so recording 4, or more, images is a good idea.

To use your flat fields, they must first have a dark frame subtracted. Although this may appear to be unimportant with such brightly lit and short exposures, there is the 'bias offset' of the camera in each image and this can produce an error in the final correction. As we are mainly interested in the bias, any very short exposure dark frame will give a good result. The dark subtracted images should then be averaged together before use.

After the above procedures have been executed, the flat field will be ready for use. Load up your image for processing, subtract the dark frame and then select 'Apply flat field' in the 'Merge' menu. The result should be an image with very little sign of the original artefacts.

The accessory ports

The SXV-M5 is provided with two ports for use with accessories. The Autoguider output port is a 6 way RJ11 socket, which is compatible with the standard autoguider input of most telescope mounts. It provides 4 active-low opto-isolator outputs and a common return line, capable of sinking a minimum of 5mA per output. This socket may be used for telescope control if the SXV-M5 is employed as an autoguider, but is primarily intended to be the control output for the optional add-on autoguider camera head, available for use with the SXV-M5.

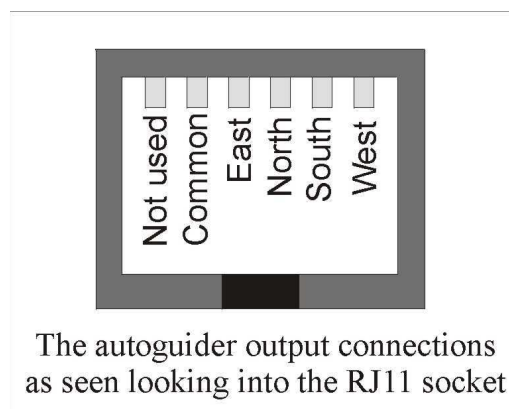

The high density parallel port socket provides both control and power for the add-on autoguider, but also includes a pair of serial ports for use with other devices.

Using the built-in serial ports

The SXV-M5 incorporates two fast serial ports for use with external accessories. The ports are available on 5 pins of the 18 way connector that is provided for the autoguider and may be accessed by plugging in a 'serial port divider box'. The divider box and cables are available as an accessory and may be chained in series with the autoguider cable, when the guider is in use, or may be used on its own.

The two serial connections are in the form of standard RS232 PC style plugs and provide TX, RX and Ground connections at RS232 levels. Access is via commands sent through the USB connection and, at the time of writing, is limited to any serial controls that are provided by the SXV software. It is expected that many more functions will be added as the software is upgraded.

STAR 2000

The SXV-M5 may be used with our patented self-guiding system 'STAR 2000'. This can greatly ease the process of recording long exposure deep-sky images.

Using 'STAR 2000' self-guiding with the SXV-M5

How S.T.A.R. 2000 works:

S.T.A.R. 2000 is a unique and patented method of automatically controlling your telescope drives, while capturing a long exposure image with your Starlight Xpress CCD camera. Unlike off-axis guiding devices and dual-CCD self-guiding cameras, S.T.A.R. 2000 can guide on almost any object, which is visible within the CCD frame! You have the entire CCD field of view to choose from and can even select a slowly moving target, such as a comet nucleus, or asteroid, to guide on during the exposure.

The principle of S.T.A.R. is based on the special CCD structure of the chips used in our SXV_M5, M7 and M9 cameras and it cannot be used with 'full frame' CCDs, such as the popular Kodak devices. It is also incompatible with our HX516 camera. The M5, M7 and M9 use 'Interline Interlaced' CCD chips, which are constructed with each pixel split into two vertically stacked halves. Each half can be 'read out' independently, so it is possible to integrate a long exposure on one field of half pixels, while the other field is read out at short intervals and the data used for guiding the telescope. Half way through the exposure, we can read out the contents of the integrating field, swap fields, and integrate the rest of the exposure on the other field. This preserves the best image resolution and eliminates 'aliasing' effects.

To give a fast guider update rate, the guiding field is read out as an 80x40 window around the guide object, while the unused lines are 'dumped'. Using this technique, it is possible to feed corrections to the telescope drive as often as one every second when guiding on a fairly bright star (typically about mag. 11). The sub-pixel guiding

accuracy of S.T.A.R. 2000 will give you tightly defined, round star images, however long the exposure time that you use!

The advantages of S.T.A.R. are very great, but there are two negative aspects, which you should be aware of. The main loss is in the sensitivity of the CCD, as only half of the pixel area is integrating an image at any one time. This is slightly offset by the halving of the dark current, which also results, and can be completely compensated for by increasing the exposure time – not a big problem when the camera can guide itself! The other problem is that the CCD amplifier must be switched on momentarily to read out each guider frame. Despite the short times involved, this results in some contamination of the upper left hand corner of the image, by light emitted from the amplifier transistors (electro luminescence), and this needs the subtraction of a special dark frame to remove it. However, the glow is quite faint and may be ignored on many images, or it can be removed with the ‘Gradient filter’ in the ‘Filters’ menu.

What you need:

To use S.T.A.R. 2000, you must have a telescope with ‘Auto guider’ capability. Most modern SCTs have this facility in the form of a 6 pin ‘RJ11’ telephone style connector on the mounting base or handset. If your ‘scope is ‘ST4 compatible’ it should work with S.T.A.R. 2000. Adaptors for other mounts, such as the Vixen Skysensor, are available from Starlight Xpress. In the case of a ‘difficult’ mount, an add-on relay box is available to switch higher currents and opposite polarity circuits. The system has been tested with the LX200, LX50 and Celestron CI700 German mounts with good results, but almost any modern mount will work well. Please note that the RJ11 cable supplied with the camera has the connectors fitted on opposite sides of the 6 way cord – other cables may not be compatible!

Setting up the system:

For best results, it is important to set up your telescope mounting as accurately as possible. Alt-Az mounts can be used with S.T.A.R. 2000, but will cause field rotation during exposures and are often rather poor at smooth tracking. We recommend that you always use an equatorially mounted ‘scope, with its polar axis accurately aligned on the pole. If your mount is prone to sudden shifts of aim point during tracking, usually due to poorly made gears or bearings, then S.T.A.R. will be unable to fully compensate and some trailing will result. Slow and smooth errors in position are well corrected and so this is what you should aim for. Check that all your drive gears are firmly fixed to their shafts (loose gears are surprisingly common!) and that they engage closely, without binding. The tracking of many mounts can be improved by adding a deliberate bias to the East. A small weight on the Eastern fork tine will usually be effective.

Connect up the computer and camera in the usual way and install the camera onto the telescope. Next, take the 6 way RJ11 telephone lead and plug one end into the guider output of the SXV camera. This output is a ‘switched’ signal, compatible with inputs designed for use with an ST4 guider. It is also possible to use a serial connection to an LX200 compatible RS232 input, but to do this you need to have a serial port to RJ11 cable from the back of the computer to the RS232 input of the mount. This connection allows other ‘goto’ control signals to be sent to the mount, but may be less convenient if you do not require this facility. Which output you use will also depend on your telescope, but the Meade LX200 and its clones are compatible with serial control,

although the LX200GPS still has a software issue at the time of writing. All other mounts will use the guider output from the camera. Once the above connections have been made, you are ready to start up the system.

Starting to guide:

Power up the camera and computer, and start the telescope drive. Click on 'Set Program Defaults' and examine the current settings. In the 'Telescope Guiding' box, set the interface selection to 'LX200', or 'Via Control box' (ST4 output of camera), as appropriate. Also select 'COM1' or 'COM2' if using serial control, according to availability - 'COM1' is the 9 pin port provided on the rear panel of most portable PC computers.

Now adjust the other values as follows:

1. Set 'RA Pixels per sec' and 'Dec Pixels per sec' to 5.
2. Set all backlash and hysteresis values to 0.
3. Set 'Ignore drift < 1 pixel' to OFF.
4. Set '70mS delay between direction changes' to ON.
5. Set 'Default guide training time' to 2 secs.

These values can be refined later, but should work reasonably well with most telescopes.

You can now test communications between the computer and telescope mount, as follows:

1. Press 'Set slew values', followed by 'Save Program Defaults'.
2. Select 'Telescope control' in the 'File' menu.
3. Press each button in turn and observe the LED lamp at the rear of the camera. As each is pressed, the lamp will brighten and change colour between red and green. The telescope will also begin to slew in the appropriate direction. This slew will be slow (unless you have deliberately selected a fast slew mode via the telescope controls) and so you will need to observe it through the telescope eyepiece, by watching stars drift by. If the LX200 output is in use, the LED will not respond, but the 'scope will still slew correctly.

If all is well, you can proceed to testing the guiding system itself, otherwise, check your setup and confirm that the correct COM port etc. is selected.

Refit the CCD camera to the telescope and rotate it so that the mounting bracket is aligned approximately East-West. Focus in the usual way on a star and then point the 'scope towards the object you have selected for imaging. I recommend something near the celestial equator and with a reasonable number of useful guide stars around it, to make life a little easier!

Take an image of the field, using an exposure time of 1 second and selecting 'Auto contrast stretch' in the 'View' menu. Several stars should be easily visible in the displayed image, but, if not, try increasing the exposure time a little. Remember that the ideal guide star is one that is bright enough to be easily detected in a 1 second exposure, or less.

Once you have the test image and can see an appropriate guide star, go to the 'File' menu and click on 'Select guide star'. Now click the mouse on the image, with the pointer on your selected star. The pointer will jump onto the star and a message box will show its co-ordinates in a message window – press 'OK' to confirm the selection. You have now selected the guide object and are ready to start an exposure.

Call up the camera control panel and select a 1 second (or the length necessary for your guide star) exposure time. Click on the check box 'Self guide next exposure' and '1 second' should appear in the self guide exposure box. Now set the exposure for the image (try 5 minutes as a good starting point) and click on 'Take picture'.

The control panel will disappear and be replaced by the guider window, with a set of number boxes above it. The guider software will now attempt to centre an 80 x 40 pixel box around the guide star and this will appear in the guider window after a few seconds delay. The number boxes will also begin to show the star co-ordinates and the differential guiding error as each new guide field is displayed.

If all is well, the error numbers will remain at generally less than 1 pixel and the star image will sit steadily at the same location in the guide box. If, however, the star begins to drift away, it is possible that your drive guide directions are reversed in either RA or DEC (or both). Press 'ESC' to stop the exposure and go back to the 'Set Program Defaults' menu, where you can use the 'Swap n/s direction' and 'Swap e/w direction' check boxes to reverse the appropriate drive. Another problem, which can arise, is that the star may remain close to the correct position, but will oscillate around it by two or three pixels, rather than holding nearly steady. This can be due to several different faults, such as poor drive accuracy, windy conditions, or bad seeing, but may also be caused by an excessive 'Loop gain' in the self-guider feedback loop. Try increasing the 'Pixels per second' values in the appropriate default setting box, until stable following is achieved. Once the guider is set up correctly, it should hold a guide star within 1 pixel of its correct position indefinitely, and you can try taking test exposures of various objects to confirm its accuracy.

After your first test of the self guider, there is a good chance that the set-up will still need some optimising. You have the option of manually setting test values of backlash and hysteresis, or using the 'Training' routine in the software. Backlash is the time delay between a reversal of a drive motor and the start of a positional correction of the telescope. Hysteresis is the time it takes for a motor to stop, after the power is removed. Many mounts have internal software to compensate for these errors, but you may need to set values other than zero to get the best performance from less sophisticated ones.

The 'Training' option can be used as follows:

Select a star to guide on, and then the drive training period, using the 'radio buttons'. The best training time will vary with the response speed of the mount, but use as long a time as possible, consistent with not losing the guide star out of the guide window.

Start the training cycle and the software will then sequentially drive the telescope in all four directions, while recording the displacement of the reference star. After the cycle has completed, the optimum correction speeds, backlash correction and hysteresis values will have been calculated and inserted into the default boxes. Note that the pixels per second rate for the R.A. correction will vary with the cosine of the declination angle, so you may need to alter this value, or re-train the system when changing between objects at widely different declinations.

Exposure times and image calibration

S.T.A.R. 2000 will enable you to greatly extend the exposure times of astronomical images and so detect much fainter objects. The limiting factor is set largely by the increasing effect of light pollution on these extended exposures, but dark sky sites will permit 30 minutes, or more, to be used. You will also begin to see signs of amplifier luminescence at the upper left-hand corner of your images and this will make dark frame subtraction more important than usual.

The software includes an option to generate properly matched dark frames, by recording the number of guiding downloads executed during the taking of the image and using this to add the correct amount of amplifier glow to the resulting dark frame. To use this option, you must record the dark frame immediately after the 'light frame', or the download count will be lost. Simply cover the 'scope aperture, select 'Take matching dark frame' in the self guider part of the camera control interface and press 'Take Photo'. Application of the 'Gradient filter' (under the Filter Menu) can be used as a final 'tweak', if necessary.

Flat field frames can be taken in the usual way, and are not affected by the use of S.T.A.R. 2000.

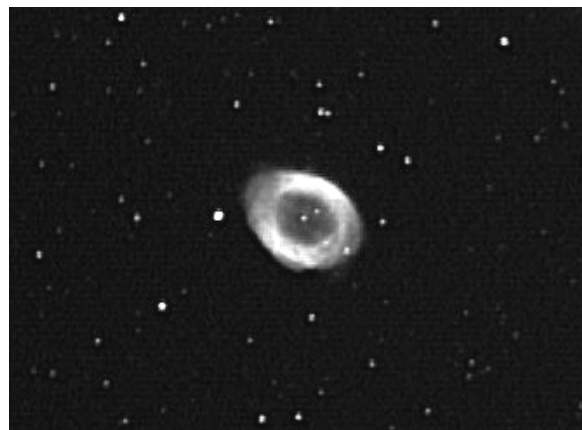

A clip from a self-guided 'STAR 2000' SXV-M5 image

Using the add-on autoguider:

An alternative to STAR2000 and a very useful accessory is the add-on autoguider head, which takes its power and control signals directly from the SXV camera, via the 18 way socket on its rear panel. The autoguider is only 1.25" in diameter and has a

video style 'CS' mount thread in its nose, so video lenses may be attached. The guider may be used with either an off-axis prism assembly mounted in front of the SXV camera, or with a separate guide telescope, rigidly mounted alongside your imaging telescope. I personally use it with an 80mm aperture F5, inexpensive refractor as a guide 'scope, but a shorter focal length lens will make more guide stars available in any given region of sky (See the picture below).

To use the autoguider, first orient it so that the connector plug is roughly parallel to the declination axis of your mount. This is not absolutely essential, as the training routine will learn the angle of the head and compensate for it, but it is easier to understand the motion of the guide star if the guider frame is aligned with the RA and Dec axes. Now connect the head to the SXV camera, using the 18 way connector lead, including the port divider box, if it is to be used.

The recommended way of connecting the autoguider output to the mount is to use an RJ11 telephone lead between the socket on the SXV camera and the autoguider input of your mount. This output is 'active low' (i.e. the control relays pull the guider inputs down to zero volts when applying a guide correction) and matches most of the autoguider inputs on commercial mounts. If 'active high' inputs are needed, or a very low control voltage drop is essential, then you will need to add a Starlight Xpress 'relay box' between the guider output and the input to the mount. Please contact your local distributor if a relay box is required. Some mounts (Vixen, for example) use a similar guider input socket, but have re-arranged connections. Details are given on our web pages at the end of the 'STAR2000' section.

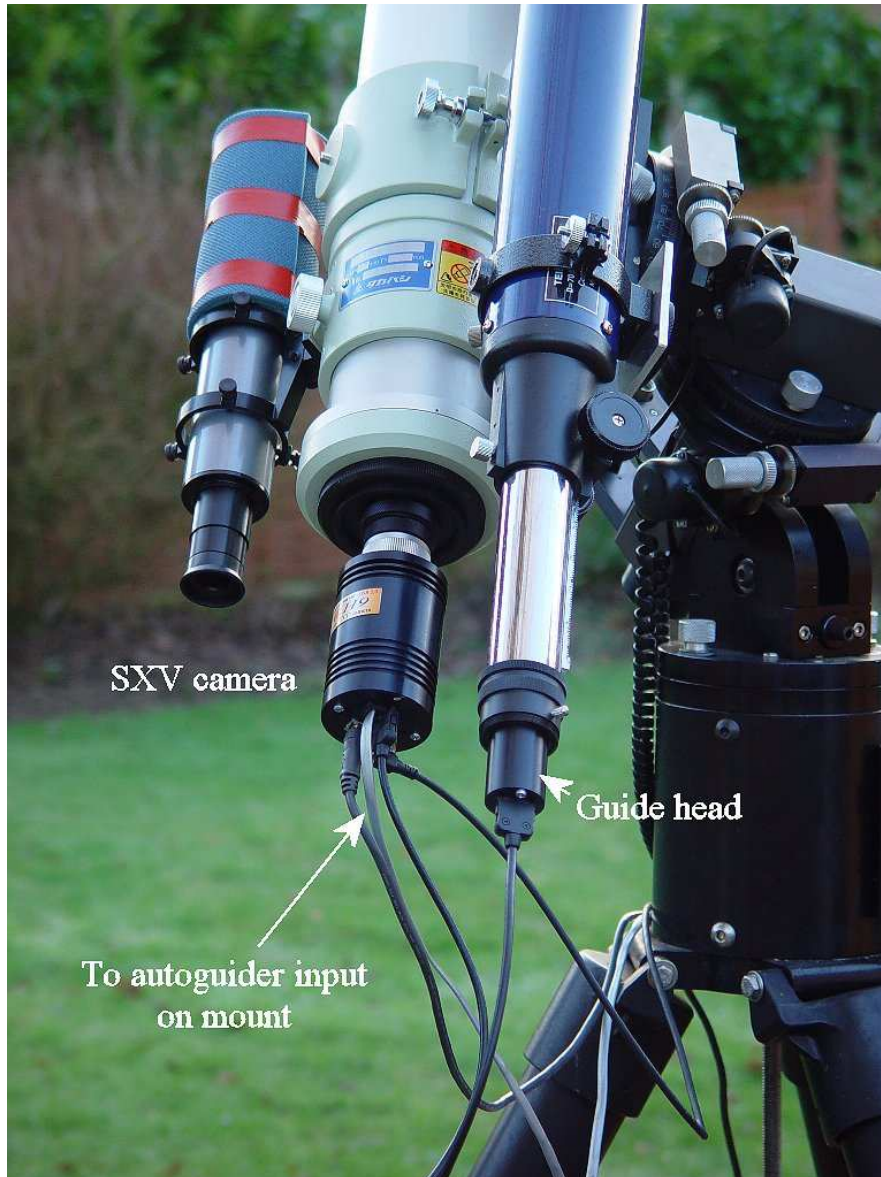

The autoguider installed on a 80mm refractor guide 'scope in the author's garden

To use the autoguider, please proceed as follows:

- 1) Having started the SXV-M5 software, open the autoguider control panel by clicking on the autoguider menu button.

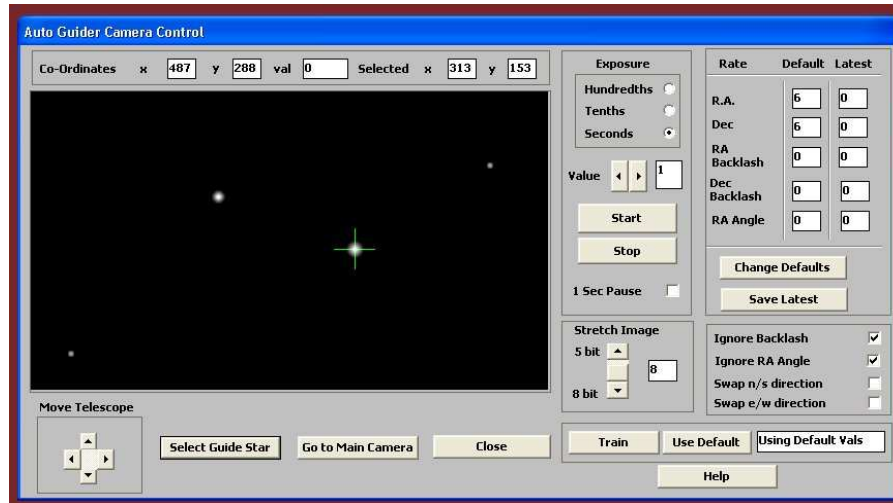

The autoguider control panel with a guide star selected

- 2) Press the 'Start' button and a series of 1 second exposure guider images will begin to appear in the picture frame. If the images look too dim, use the 'Stretch Image' slider to increase its contrast and brightness until the noise begins to be visible.
- 3) If you haven't focused the guider lens or 'scope, move the mount until a bright star is visible on the guider image and then adjust the focus until it is as sharp as possible.
- 4) At this point, you may want to test the guiding control by pressing the manual 'Move Telescope' buttons at the bottom left corner of the control panel. You can watch the position of any stars in the guider image and confirm that they move in response to the buttons. The movement should be slow if the correct guiding rate is selected on your mount (typically 2x sidereal). Adjust this, if necessary.
- 5) Move the mount until the required object for imaging is properly framed in the main CCD image (leave the guider menu and use the main camera control panel, as necessary).
- 6) Re-open the guider control panel, start imaging and try to locate a clearly visible guide star. If necessary, make adjustments to the guide telescope or off-axis guider until one is found.
- 7) Press 'Stop' and then press 'Select Guide Star'. Use the mouse to left click on the selected star and a green cross will highlight it and the co-ordinates will appear in the text boxes above the image window.
- 8) The various guiding rate defaults, listed on the right-hand side of the control panel, are unlikely to be perfect for your particular telescope and mount. You have the option of manually selecting values, or asking the software to attempt to determine what they should be. This is done by pressing the 'Train' button and waiting for the software to complete a sequence of automatic moves and calculations. The training will also determine the angle at which the guide camera is oriented with respect to the RA and Dec axes. If you do not wish to train the system at this time, the default values of 6 pixels per second will serve as a starting point.
- 9) Now press 'Go to main camera' and the guider control panel will be replaced by the camera control panel. Set the required exposure time for the image (say

5 minutes) and press the 'Autoguide next image' button. The autoguider window will reappear and, after a few seconds, you should see error values appearing in the text windows at the top. The guide star will be fairly close to the green cross, although not necessarily accurately centred, and you should see the power/ guide LED on the rear of the camera brighten and change colour with each correction.

- 10) If the star begins to drift away from the cross, despite the corrections being made, the chances are that the N/S and/or E/W directions are set wrongly. Judge which axis is incorrectly set by observing the direction of the drift and then stop the exposure by pressing 'Esc'. Open the guider control panel and check the appropriate swap box(es). After this operation, you will probably need to find the guide star again by taking a guider image and reselecting the star, as before. Now return to the main camera menu and try the 'Autoguide next image' button again.
- 11) Once guiding is taking place without problems, the main exposure can be allowed to finish and, if all is well, you should see an image with tiny circular stars.

If the stars are not circular, you may need to alter the guiding parameters, or investigate the rigidity and drive performance of your mount. A lot of information can be deduced by watching the behaviour of the guide star in the guider frame. If it is continually moving between two locations, either side of the green cross, then the RA or Dec pixels per second value is set too low. The higher these values are set, the gentler the guiding becomes. Too low a value will cause an over-aggressive correction to be made and result in oscillation of the star position between two points.

Another source of guiding errors can be a too accurately balanced telescope mount! Good balance can result in the telescope mount 'bouncing' between the gear teeth as corrections are made. A simple fix is to add a weight of about 0.5kg (1 pound) on the eastern end of the declination axis, so that there is always some pressure acting against the gear teeth.

Getting a good result from an autoguider will often entail a lot of detective work to eliminate the sources of gear error, telescope flexure, mirror shift etc., but the final result is well worth the effort!

Camera maintenance:

Very little maintenance is needed to keep the SXV-M5 in excellent operating order, however two problems, which are common to all CCD equipment, are likely to show up on occasion. These are dust and condensation.

Removing Dust:

- 1) Dust can be deposited on either the optical window (not a big problem to cure), or on the CCD faceplate (difficult to eliminate entirely). When small particles collect on the window they may not be noticed at all on deep sky (small F ratio) images, as they

will be very much out of focus. However, if a powerful contrast boost of the image is carried out, they may well begin to show as the shadow 'Do-nuts' mentioned earlier. Images taken with a large F ratio optical system are more likely to be affected by such dirt, owing to the smaller and sharper shadows that they cast. There is no great difficulty in removing such particles on the outside surface by the careful use of a lens cleaning cloth or 'air duster' and so you should have little trouble with this aspect of maintenance. Dust on the CCD faceplate is a much greater nuisance, as it casts very sharply defined and dark shadows and it entails dismantling the camera to get rid of it! To clean the CCD you will need a good quality lens cloth (no silicone) or tissues and some high-grade isopropyl alcohol. A very suitable cloth is the 'Micro-Fibre' type marketed by PENTAX etc., and suitable alcohol is available from TANDY (Radio Shack) etc. as tape head cleaning fluid. A bright light and a strong watchmakers eyeglass will also be found essential.

Procedure:

- 1) Disconnect the lead from the camera head and remove it from the telescope. Place it on a table with the optical window facing downward.
- 2) Remove the two M3 screws from the camera back plate and ease the plate out of the camera body. You may need to press down with a finger on the USB socket while pulling up on the camera barrel to overcome the friction.
- 3) Withdraw the body cylinder and unscrew the two long spacer pillars from the heat sink plate assembly.
- 4) The entire camera electronic assembly can now be lifted away from the camera front barrel and the CCD will be readily accessible. Note that a layer of white heat-sink compound is applied to the periphery of the heat sink disc and this should be left undisturbed by subsequent operations.
- 5) You can now closely examine the CCD faceplate under the spotlight using the watchmaker's glass when any dust motes will show clearly. If there is only an odd particle or two and the CCD is otherwise clean, carefully brush away the dust with a corner of your lens cloth. A smeared or very dusty CCD will need a few drops of alcohol to clean thoroughly and you may have to make several attempts before the surface is free of contamination. One gentle wipe from one end to the other, with no return stroke, will be found to be the most effective action. DO NOT rub vigorously and be very careful to avoid scratching the window.
- 6) Before re-assembly, make certain that the inside surface of the front window is also clean, and then carefully replace the camera front barrel and screw it into place. (If the heat sink seal is disturbed, renew it with fresh compound before reassembling).
- 7) Replace all the camera parts in reverse order and the job is done.

Dealing with condensation:

The SXV-M5 is designed to avoid condensation by minimising the volume of air trapped within the CCD cavity. This normally works quite well, but storage of the camera in a humid location can lead to the trapped air becoming moist by diffusion through the optical window mounting thread etc. and result in condensation on the CCD window. If this becomes a problem, try to store the camera in a warm, dry place, or in a plastic lunch box containing a sachet of silica gel desiccant.

N.B. DO NOT leave the camera switched on for long periods between uses. The cold CCD will collect ice by slow diffusion through any small leaks and this will become corrosive water on the cooler and CCD pins when the power is removed. If substantial amounts of moisture are seen on the CCD, dismantle the camera and dry it thoroughly.

Alternative Software

Although we hope that you will be satisfied with 'SXV_M5', other companies are offering alternative software. The most active and successful of these is 'AstroArt' by MSB software. You can purchase AstroArt from many dealers Worldwide and more information may be obtained from their web site at <http://www.msb-astroart.com>

Maxim DL is also a very popular option and may be purchased from many astronomical equipment dealers. Their web site is at <http://www.cyanogen.com>

Some details of the camera and CCD characteristics

CCD type: Sony ICX405AL 'SuperHAD' interline CCD imager.

CCD size: Active area 4.9 x 3.65mm

Pixel size: 9.8 x 6.3uM

QE peak: approx. 60% at 540nm

Spectral response:

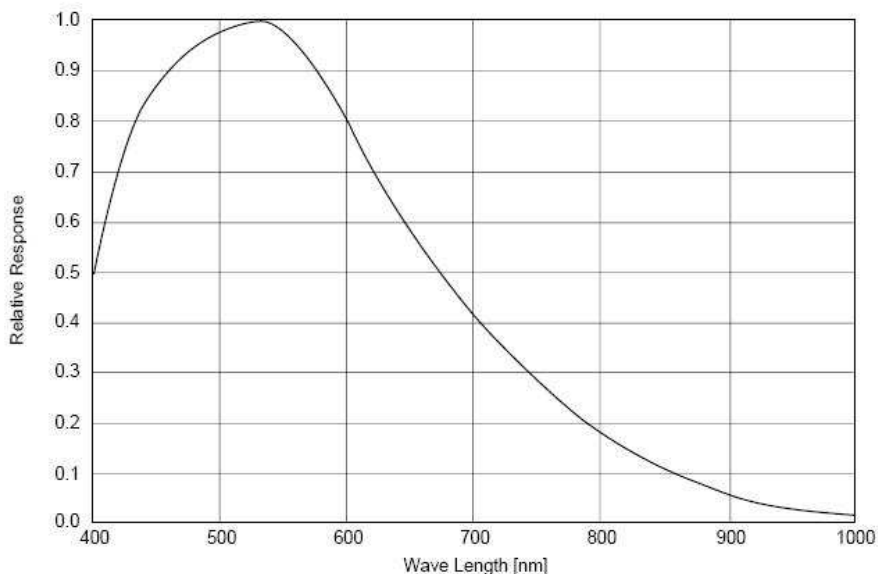

Power consumption: 220v / 110v AC @ 12 watts max., 12v DC @ 750mA

Dear User,

Thank you for purchasing a Starlight Xpress CCD Imaging System. We are confident that you will gain much satisfaction from this equipment, but please read carefully the accompanying instruction manual to ensure that you achieve the best performance that is capable of providing.

As with most sophisticated equipment a certain amount of routine maintenance is necessary to keep the equipment operating at its optimum performance. The maintenance has been kept to a minimum, and is fully described in the manual.

In the unfortunate instance when the equipment does not perform as expected, may we recommend that you first study the fault finding information supplied. If this does not remedy the problem, then contact Starlight Xpress for further advice. Our message board service on the Starlight Xpress web site will often provide solutions to any problems.

The equipment is covered by a 12-month guarantee covering faulty design, material or workmanship in addition to any statutory Consumer Rights of Purchasers.

CONDITIONS OF GUARANTEE

- 1) The equipment shall only be used for normal purposes described in the standard operating instructions, and within the relevant safety standards of the country where the equipment is used.
- 2) Repairs under guarantee will be free of charge providing proof of purchase is produced, and that the equipment is returned to the Service Agent at the Purchaser's expense and risk, and that the equipment proves to be defective.
- 3) The guarantee shall not apply to equipment damaged by fire, accident, wear and tear, misuse, unauthorised repairs, or modified in any way whatsoever, or damage suffered in transit to or from the Purchaser.
- 4) The Purchaser's sole and exclusive rights under this guarantee is for repair, or at our discretion the replacement of the equipment or any part thereof, and no remedy to consequential loss or damage whatsoever.
- 5) This guarantee shall not apply to components that have a naturally limited life.
- 6) Starlight Xpress's decision in all matters is final, and any faulty component which has been replaced will become the property of Starlight Xpress Ltd.

For further info. or advice, please call:

Mr Michael Hattey,

Starlight Xpress Ltd.,

The Office, Foxley Green Farm,

Ascot Road, Holyport,

Berkshire,

England. SL6 3LA

Tel: 01628 777126

Fax: 01628 580411

e-mail: Michael.hattey@starlight-xpress.co.uk

Web site: <http://www.starlight-xpress.co.uk>